



**TUBO IN ACCIAIO INOX NERO E BIANCO**  
Catalogo e Listino 13

**STAINLESS STEEL BLACK AND WHITE CHIMNEY**  
Catalog and Price List 13

**NORME - STANDARDS**

UNI EN 1856-1:2009

UNI EN 1856-2:2009

UNI/TS 11278:2008



# TUBO IN ACCIAIO INOX NERO E BIANCO

## STAINLESS STEEL BLACK AND WHITE CHIMNEY

Tubo in acciaio inox verniciato HT 200°, conforme alle norme UNI EN 1856-2:2009, UNI EN 1856-2:2009 e UNI/TS 11278:2008, adatto per l'utilizzo con stufe e caldaie alimentate a gas e pellet, ottima resistenza alla corrosione.

*Painted HT 200° stainless steel chimney, in according with european standard UNI EN 1856-1:2009 and UNI EN 1856-2:2009, suitable for use with boiler and stove powered by gas and pellet, excellent resistance to corrosion.*

**ELEMENTO DIRITTO MT. 2 \***  
**STRAIGHT ELEMENT MT. 2 \***

**Ø 80 PZ. X CONF. - PCS FOR BOX: 6**

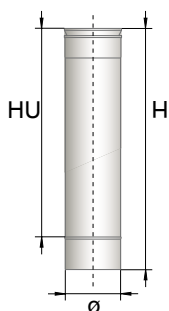

					DIMENSIONI IN MM. DIMENSIONS IN MM.		
Ø	CODICE CODE	EAN 13	COLORE COLOR	EURO	H	HU	
80	PPED20080X	8028653124005	NERO BLACK	48,00	2000	1950	

**ELEMENTO DIRITTO MT. 1,5 \***  
**STRAIGHT ELEMENT MT. 1,5 \***

**Ø 80 PZ. X CONF. - PCS FOR BOX: 6**

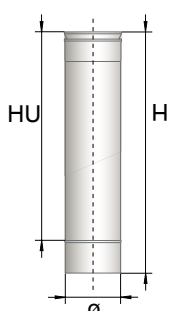

					DIMENSIONI IN MM. DIMENSIONS IN MM.		
Ø	CODICE CODE	EAN 13	COLORE COLOR	EURO	H	HU	
80	PPED15080X	8028653124012	NERO BLACK	38,40	1500	1450	

**\***

Gli elementi dritti da 2 mt. e da 1,5 mt. verranno spediti con corriere esclusivamente in lotti da 48 pz., anche assortiti. Ordini con quantità inferiori ai 48 pz. verranno evasi esclusivamente in porto assegnato con ritiro diretto da parte del cliente.

*The straight elements length 2 mt. and 1,5 mt. are delivered only in 48 pcs lots, assorted also.*

**ELEMENTO DIRITTO MT. 1**  
**STRAIGHT ELEMENT MT. 1**

**Ø 80 PZ. X CONF. - PCS FOR BOX: 2**  
**Ø 100 PZ. X CONF. - PCS FOR BOX: 6**

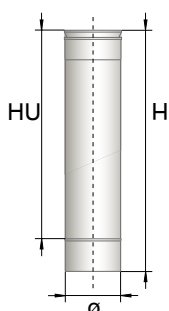

					DIMENSIONI IN MM. DIMENSIONS IN MM.		
Ø	CODICE CODE	EAN 13	COLORE COLOR	EURO	H	HU	
80	PPED01080X	8028653123008	NERO BLACK	19,79	1000	950	
80	PBED01080X	8028653123473	BIANCO WHITE	19,79	1000	950	
100	PPED01100X	8028653123015	NERO BLACK	23,50	1000	950	
100	PBED01100X	8028653123480	BIANCO WHITE	23,50	1000	950	

**ELEMENTO DIRITTO MT. 0,5**  
**STRAIGHT ELEMENT MT. 0,5**

**Ø 80 PZ. X CONF. - PCS FOR BOX: 2**  
**Ø 100 PZ. X CONF. - PCS FOR BOX: 6**

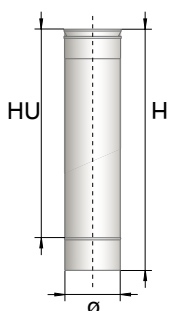

Ø	CODICE CODE	EAN 13	COLORE COLOR	EURO	DIMENSIONI IN MM. DIMENSIONS IN MM.		
					H	HU	
80	PPED02080X	8028653123039	NERO BLACK	13,44	500	450	
80	PBED02080X	8028653123497	BIANCO WHITE	13,44	500	450	
100	PPED02100X	8028653123046	NERO BLACK	16,12	500	450	
100	PBED02100X	8028653123503	BIANCO WHITE	16,12	500	450	

**ELEMENTO DIRITTO MT. 0,25**  
**STRAIGHT ELEMENT MT. 0,25**

**Ø 80 PZ. X CONF. - PCS FOR BOX: 2**  
**Ø 100 PZ. X CONF. - PCS FOR BOX: 6**

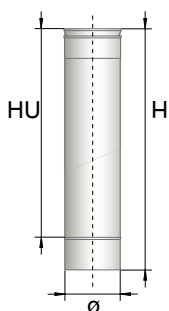

Ø	CODICE CODE	EAN 13	COLORE COLOR	EURO	DIMENSIONI IN MM. DIMENSIONS IN MM.		
					H	HU	
80	PPED03080X	8028653123060	NERO BLACK	10,00	250	200	
80	PBED03080X	8028653123510	BIANCO WHITE	10,00	250	200	
100	PPED03100X	8028653123077	NERO BLACK	12,00	250	200	
100	PBED03100X	8028653123527	BIANCO WHITE	12,00	250	200	

**ELEMENTO TELESCOPICO**  
**TELESCOPIC ELEMENT**

**Ø 80 PZ. X CONF. - PCS FOR BOX: 1**  
**Ø 100 PZ. X CONF. - PCS FOR BOX: 1**

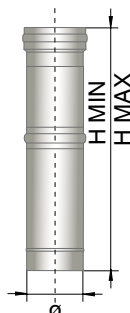

Ø	CODICE CODE	EAN 13	COLORE COLOR	EURO	DIMENSIONI IN MM. DIMENSIONS IN MM.		
					H MIN	H MAX	
80	PPET04080X	8028653123398	NERO BLACK	22,70	300	600	
80	PBET04080X	8028653123732	BIANCO WHITE	22,70	300	600	
100	PPET04100X	8028653123404	NERO BLACK	26,30	300	600	
100	PBET04100X	8028653123749	BIANCO WHITE	26,30	300	600	

**CURVA 90°**  
**CURVE 90°**

**Ø 80 PZ. X CONF. - PCS FOR BOX: 2**  
**Ø 100 PZ. X CONF. - PCS FOR BOX: 6**

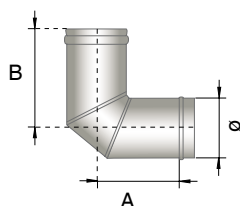

D\*: DISASSAMENTO - MISALIGNMENT

Ø	CODICE CODE	EAN 13	COLORE COLOR	EURO	DIMENSIONI IN MM. DIMENSIONS IN MM.		
					A	B	D*
80	PPC90080X	8028653123152	NERO BLACK	17,95	80	130	220
80	PBC90080X	8028653123572	BIANCO WHITE	17,95	80	130	220
100	PPC90100X	8028653123169	NERO BLACK	20,87	100	150	260
100	PBC90100X	8028653123589	BIANCO WHITE	20,87	100	150	260

**CURVA 45°**  
**CURVE 45°**

**Ø 80 PZ. X CONF. - PCS FOR BOX: 2**  
**Ø 100 PZ. X CONF. - PCS FOR BOX: 6**

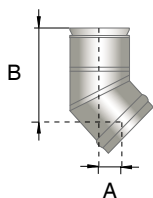

D\*: DISASSAMENTO - MISALIGNMENT

Ø	CODICE CODE	EAN 13	COLORE COLOR	EURO	DIMENSIONI IN MM. DIMENSIONS IN MM.		
					A	B	D*
80	PPCQ45080X	8028653123183	NERO BLACK	15,93	30	120	100
80	PBCQ45080X	8028653123596	BIANCO WHITE	15,93	30	120	100
100	PPCQ45100X	8028653123190	NERO BLACK	17,05	30	120	100
100	PBCQ45100X	8028653123602	BIANCO WHITE	17,05	30	120	100

**RACCORDO A TEE 90° FEMMINA MASCHIO - MASCHIO CON TAPPO CONDENSA CHIUSO\***  
**TEE JOINT 90° FEMALE MALE - MALE WITH CLOSED CONDENSATION CAP\***

**Ø 80 PZ. X CONF. - PCS FOR BOX: 2**  
**Ø 100 PZ. X CONF. - PCS FOR BOX: 6**

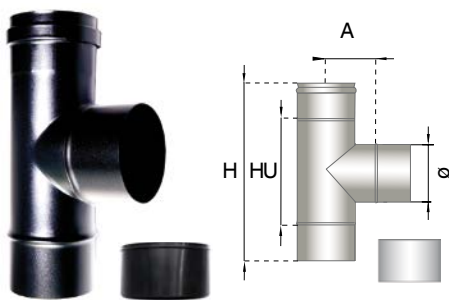

					DIMENSIONI IN MM. DIMENSIONS IN MM.		
Ø	CODICE CODE	EAN 13	COLORE COLOR	EURO	H	HU	A
80	PPRT08080XM*	8028653123305	NERO BLACK	25,90	195	95	65
80	PBRT08080XM	8028653123657	BIANCO WHITE	25,90	195	95	65
100	PPRT08100XM	8028653123312	NERO BLACK	28,80	195	95	75
100	PBRT08100XM	8028653123664	BIANCO WHITE	28,80	195	95	75

**RACCORDO A TEE 90° FEMMINA MASCHIO - FEMMINA CON TAPPO CONDENSA CHIUSO\***  
**TEE JOINT 90° FEMALE MALE - FEMALE WITH CLOSED CONDENSATION CAP\***

**Ø 80 PZ. X CONF. - PCS FOR BOX: 2**  
**Ø 100 PZ. X CONF. - PCS FOR BOX: 6**

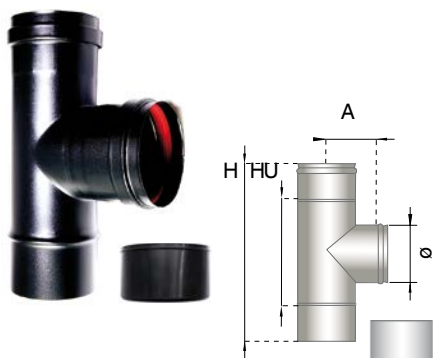

					DIMENSIONI IN MM. DIMENSIONS IN MM.		
Ø	CODICE CODE	EAN 13	COLORE COLOR	EURO	H	HU	A
80	PPRT08080XF*	8028653123213	NERO BLACK	25,90	195	95	65
80	PBRT08080XF	8028653123619	BIANCO WHITE	25,90	195	95	65
100	PPRT08100XF	8028653123220	NERO BLACK	28,80	195	95	75
100	PBRT08100XF	8028653123626	BIANCO WHITE	28,80	195	95	75

\*

Il tappo condensa chiuso D. 80 nero, realizzato in materiale siliconico, può essere applicato sia sul lato maschio che sul lato femmina, permettendo con solo due raccordi TEE di realizzare tutte le combinazioni richieste, con una riduzione degli articoli a magazzino.

*The closed condensation cap D. 80 black, made by siliconic material, can be applied on male and female side, allowing with only two TEE joint making all requested combinations, reducing the inventory items.*

**RACCORDO A TEE 90° FEMMINA MASCHIO - FEMMINA RIDOTTO D. 80 CON TAPPO CONDENSA CHIUSO**  
**TEE JOINT 90° FEMALE MALE - REDUCED FEMALE D. 80 WITH CLOSED CONDENSATION CAP**

**Ø 100 PZ. X CONF. - PCS FOR BOX: 1**

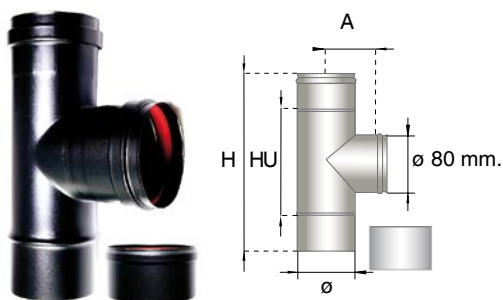

					DIMENSIONI IN MM. DIMENSIONS IN MM.		
Ø	CODICE CODE	EAN 13	COLORE COLOR	EURO	H	HU	A
100	PPRT80100XF	8028653123961	NERO BLACK	33,13	195	95	75
100	PBRT80100XF	8028653123985	BIANCO WHITE	33,13	195	95	75

**RACCORDO A TEE 90° FEMMINA MASCHIO - MASCHIO RIDOTTO D. 80 CON TAPPO CONDENSA CHIUSO**  
**TEE JOINT 90° FEMALE MALE - REDUCED MALE D. 80 WITH CLOSED CONDENSATION CAP**

**Ø 100 PZ. X CONF. - PCS FOR BOX: 1**

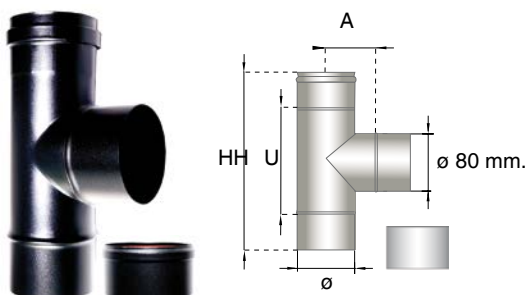

					DIMENSIONI IN MM. DIMENSIONS IN MM.		
Ø	CODICE CODE	EAN 13	COLORE COLOR	EURO	H	HU	A
100	PPRT80100XM	8028653123992	NERO BLACK	33,13	195	95	75
100	PBRT80100XM	8028653123978	BIANCO WHITE	33,13	195	95	75



**TAPPO CONDENZA CHIUSO \***  
**CLOSED CONDENSATION CAP \***

Ø 80 PZ. X CONF. - PCS FOR BOX: 1

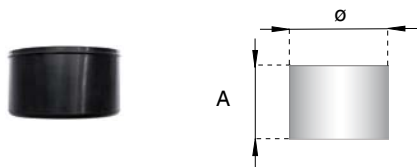

Ø	CODICE CODE	EAN 13	COLORE COLOR	EURO	DIMENSIONI IN MM. DIMENSIONS IN MM.		
					A		
80	PPTC85080XC*	8028653123435	NERO BLACK	7,49	45		
80	PBTC85080XC	8028653123770	BIANCO WHITE	7,49	60		

\*Il modello nero realizzato in materiale silconico, può essere applicato sia sul lato maschio che sul lato femmina.

\*The black model made by silconic material, can be applied on male and female side.

**TAPPO CONDENZA CON DRENAGGIO**  
**CONDENSATION CAP WITH DRAINAGE**

Ø 80 PZ. X CONF. - PCS FOR BOX: 1  
Ø 100 PZ. X CONF. - PCS FOR BOX: 1

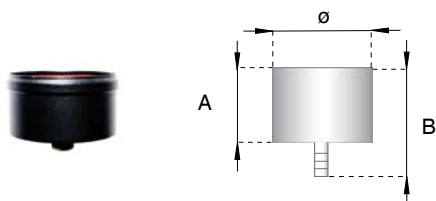

Ø	CODICE CODE	EAN 13	COLORE COLOR	EURO	DIMENSIONI IN MM. DIMENSIONS IN MM.		
					A	B	
80	PPTC85080X	8028653123442	NERO BLACK	17,00	60	95	
80	PBTC85080X	8028653123787	BIANCO WHITE	17,00	60	95	
100	PPTC85100X	8028653124029	NERO BLACK	19,00	60	95	
100	PBTC85100X	8028653124036	BIANCO WHITE	19,00	60	95	

**ROSONE PICCOLO**  
**LITTLE CIRCLE FRAME**

Ø 80 PZ. X CONF. - PCS FOR BOX: 1

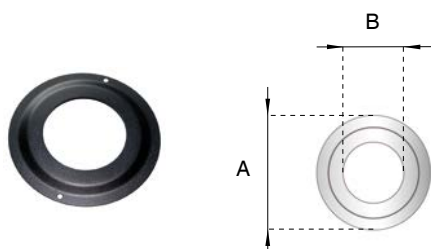

Ø	CODICE CODE	EAN 13	COLORE COLOR	EURO	DIMENSIONI IN MM. DIMENSIONS IN MM.		
					A	B	
80	PPROSONE080P	8028653123459	NERO BLACK	10,97	150	82	
80	PBROSONE080P	8028653123794	BIANCO WHITE	10,97	150	82	

**ROSONE**  
**CIRCLE FRAME**

Ø 80 PZ. X CONF. - PCS FOR BOX: 1  
Ø 100 PZ. X CONF. - PCS FOR BOX: 1

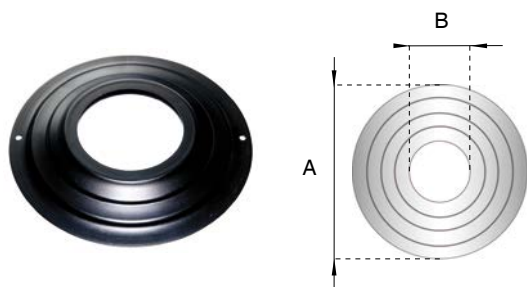

Ø	CODICE CODE	EAN 13	COLORE COLOR	EURO	DIMENSIONI IN MM. DIMENSIONS IN MM.		
					A	B	
80	PPROSONE080	8028653121905	NERO BLACK	13,01	230	82	
80	PBROSONE080X	8028653123695	BIANCO WHITE	13,01	230	82	
100	PPROSONE100	8028653121912	NERO BLACK	16,00	230	102	
100	PBROSONE100X	8028653123701	BIANCO WHITE	16,00	230	102	

**ROSONE CON TRONCHETTO**  
**CIRCLE FRAME WITH FLUE ADAPTER**

Ø 80 PZ. X CONF. - PCS FOR BOX: 1  
Ø 100 PZ. X CONF. - PCS FOR BOX: 1

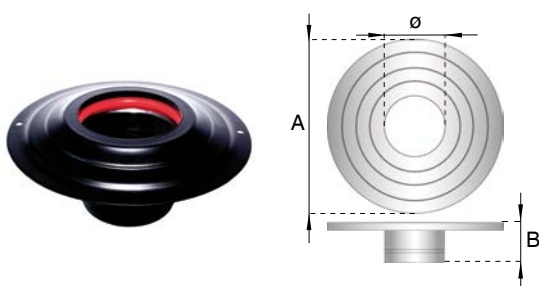

Ø	CODICE CODE	EAN 13	COLORE COLOR	EURO	DIMENSIONI IN MM. DIMENSIONS IN MM.		
					A	B	
80	PPROSONE080XT	8028653123466	NERO BLACK	15,00	230	80	
80	PBROSONE080XT	8028653123800	BIANCO WHITE	15,00	230	80	
100	PPROSONE100XT	8028653124043	NERO BLACK	17,00	230	80	
100	PBROSONE100XT	8028653124050	BIANCO WHITE	17,00	230	80	

**CAPPELLO CINESE FEMMINA**  
**FEMALE CHINESE CAP**

**Ø 80 PZ. X CONF. - PCS FOR BOX: 1**  
**Ø 100 PZ. X CONF. - PCS FOR BOX: 1**

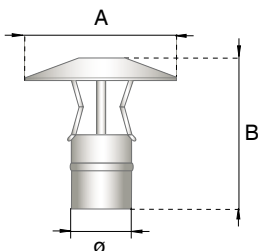

**DIMENSIONI IN MM.**  
**DIMENSIONS IN MM.**

Ø	CODICE CODE	EAN 13	COLORE COLOR	EURO	A	B	
80	PPCC06080X	8028653123275	NERO BLACK	29,00	200	200	
80	PBCC06080X	8028653123671	BIANCO WHITE	29,00	200	200	
100	PPCC06100X	8028653123282	NERO BLACK	30,00	200	200	
100	PBCC06100X	8028653123688	BIANCO WHITE	30,00	200	200	

**CAPPELLO CINESE MASCHIO**  
**MALE CHINESE CAP**

**Ø 80 PZ. X CONF. - PCS FOR BOX: 1**  
**Ø 100 PZ. X CONF. - PCS FOR BOX: 1**

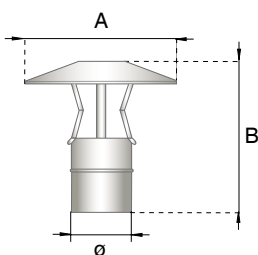

**DIMENSIONI IN MM.**  
**DIMENSIONS IN MM.**

Ø	CODICE CODE	EAN 13	COLORE COLOR	EURO	A	B	
80	PPCC06080XM	8028653124067	NERO BLACK	29,00	200	240	
80	PBCC06080XM	8028653124081	BIANCO WHITE	29,00	200	240	
100	PPCC06100XM	8028653124074	NERO BLACK	30,00	200	240	
100	PBCC06100XM	8028653124098	BIANCO WHITE	30,00	200	240	

**TERMINALE SCARICO A PARETE**  
**END WALL SAWAGE**

**Ø 80 PZ. X CONF. - PCS FOR BOX: 1**  
**Ø 100 PZ. X CONF. - PCS FOR BOX: 1**

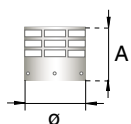

**DIMENSIONI IN MM.**  
**DIMENSIONS IN MM.**

Ø	CODICE CODE	EAN 13	COLORE COLOR	EURO	A		
80	PPSP52080X	8028653123893	NERO BLACK	14,80	70		
80	PBSP52080X	8028653123930	BIANCO WHITE	14,80	70		
100	PPSP52100X	8028653123909	NERO BLACK	15,80	70		
100	PBSP52100X	8028653123947	BIANCO WHITE	15,80	70		

**TRONCHETTO FEMMINA - FEMMINA**  
**FEMALE - FEMALE FLUE ADAPTER**

**Ø 80 PZ. X CONF. - PCS FOR BOX: 1**  
**Ø 100 PZ. X CONF. - PCS FOR BOX: 1**

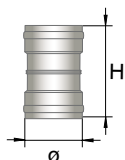

**DIMENSIONI IN MM.**  
**DIMENSIONS IN MM.**

Ø	CODICE CODE	EAN 13	COLORE COLOR	EURO	H		
80	PPED04080X	8028653123091	NERO BLACK	10,00	120		
80	PBED04080X	8028653123534	BIANCO WHITE	10,00	120		
100	PPED04100X	8028653123107	NERO BLACK	12,00	120		
100	PBED04100X	8028653123541	BIANCO WHITE	12,00	120		

**TRONCHETTO MASCHIO - MASCHIO**  
**MALE - MALE FLUE ADAPTER**

**Ø 80 PZ. X CONF. - PCS FOR BOX: 1**  
**Ø 100 PZ. X CONF. - PCS FOR BOX: 1**

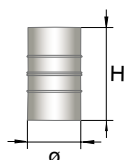

**DIMENSIONI IN MM.**  
**DIMENSIONS IN MM.**

Ø	CODICE CODE	EAN 13	COLORE COLOR	EURO	H		
80	PPED04M080X	8028653123121	NERO BLACK	7,10	120		
80	PBED04M080X	8028653123558	BIANCO WHITE	7,10	120		
100	PPED04M100X	8028653123138	NERO BLACK	8,50	120		
100	PBED04M100X	8028653123565	BIANCO WHITE	8,50	120		

**RIDUZIONE D.100 FEMMINA - D. 80 MASCHIO**  
**CUT LENGTH ADAPTOR D. 100 FEMALE - D. 80 MALE**

Ø 100 PZ. X CONF. - PCS FOR BOX: 1

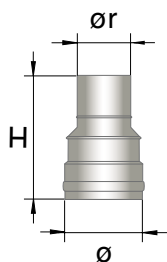

Ø	CODICE CODE	EAN 13	COLORE COLOR	EURO	DIMENSIONI IN MM. DIMENSIONS IN MM.		
					H	Ør	
100	PPRC09100XF	8028653124104	NERO BLACK	41,70	160	80	
100	PBRC09100XF	8028653124128	BIANCO WHITE	41,70	160	80	

**RIDUZIONE D.100 MASCHIO - D. 80 MASCHIO**  
**CUT LENGTH ADAPTOR D. 100 MALE - D. 80 MALE**

Ø 100 PZ. X CONF. - PCS FOR BOX: 1

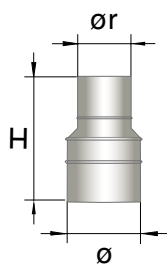

Ø	CODICE CODE	EAN 13	COLORE COLOR	EURO	DIMENSIONI IN MM. DIMENSIONS IN MM.		
					H	Ør	
100	PPRC09100XM	8028653124111	NERO BLACK	41,70	160	80	
100	PBRC09100XM	8028653124135	BIANCO WHITE	41,70	160	80	

**RIDUZIONE D.120 FEMMINA - D. 80 MASCHIO**  
**CUT LENGTH ADAPTOR D. 120 FEMALE - D. 80 MALE**

Ø 120 PZ. X CONF. - PCS FOR BOX: 1

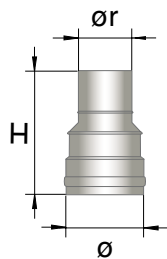

Ø	CODICE CODE	EAN 13	COLORE COLOR	EURO	DIMENSIONI IN MM. DIMENSIONS IN MM.		
					H	Ør	
120	PPRC09120XF	8028653124142	NERO BLACK	42,15	160	80	
120	PBRC09120XF	8028653124166	BIANCO WHITE	42,15	160	80	

**RIDUZIONE D.120 MASCHIO - D. 80 MASCHIO**  
**CUT LENGTH ADAPTOR D. 120 MALE - D. 80 MALE**

Ø 120 PZ. X CONF. - PCS FOR BOX: 1

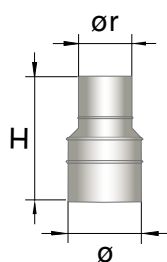

Ø	CODICE CODE	EAN 13	COLORE COLOR	EURO	DIMENSIONI IN MM. DIMENSIONS IN MM.		
					H	Ør	
120	PPRC09120XM	8028653124159	NERO BLACK	42,15	160	80	
120	PBRC09120XM	8028653124173	BIANCO WHITE	42,15	160	80	

**FASCETTA DI BLOCCAGGIO**  
**LOCK CLAMP**

Ø 80 PZ. X CONF. - PCS FOR BOX: 1  
 Ø 100 PZ. X CONF. - PCS FOR BOX: 1

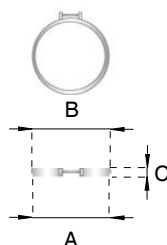

Ø	CODICE CODE	EAN 13	COLORE COLOR	EURO	DIMENSIONI IN MM. DIMENSIONS IN MM.		
					A	B	C
80	PPFB19080X	8028653123411	NERO BLACK	3,77	80	82	20
80	PBFB19080X	8028653123756	BIANCO WHITE	3,77	80	82	20
100	PPFB19100X	8028653123428	NERO BLACK	3,97	100	102	20
100	PBFB19100X	8028653123763	BIANCO WHITE	3,97	100	102	20

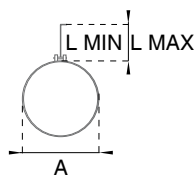

Ø	CODICE CODE	EAN 13	COLORE COLOR	EURO	DIMENSIONI IN MM. DIMENSIONS IN MM.		
					A	L MIN	L MAX
80	PPFM14080X	8028653122131	NERO BLACK	9,00	82	20	95
100	PBFM14080X	8028653123718	BIANCO WHITE	9,00	82	20	95
80	PPFM14100X	8028653122148	NERO BLACK	9,80	102	20	95
100	PBFM14100X	8028653123725	BIANCO WHITE	9,80	102	20	95

**SPECIFICHE TECNICHE**  
**TECHNICAL SPECIFICATIONS**

Costruito in ACCIAIO INOX AISI 316 L spessore 0,4 mm.  
 Made out of STAINLESS STEEL AISI 316 L thickness 0,4 mm.

Descrizione del prodotto: Sistema camino  
 Product description: Chimney system

Norme: EN1856-1.2009, EN1856-2.2009, UNI/TS 11278:2008  
 Normatives: EN1856-1.2009, EN1856-2:2009, UNI/TS 11278:2008

Livello di temperatura: 200°C  
 Temperature level: 200°C

Livello di pressione: P1  
 Pressure level: P1

Resistenza alla condensa: Umido  
 Condensation resistance: Moist

Resistenza alla corrosione: V2  
 Corrosion resistance: V2

Specifiche della parte interna: L50040  
 Internal wall specification: L50040

Resistenza al fuoco da dentro e distanza dai materiali combustibili: O  
 Internal fire resistance and distance from the combustible materials: O



# KIT DI INSTALLAZIONE INSTALLATION KIT

Kit di installazione completi, contenenti tutto il necessario per un'installazione standard.

Si possono realizzare kit personalizzati, quantità minima: 10 kit.

*Full installation kit, containing the necessary for standard installation.*

*We can realize customized kit, minimum quantity: 10 kit.*

**KIT COMPLETO MOD. 0**  
**FULL KIT MOD. 0**

**PZ. X CONF. - PCS FOR BOX: 1**



Ø	CODICE CODE	EAN 13	COLORE COLOR	EURO		
80	PPKIT080	8028653123817	NERO BLACK	115,81		
80	PBKIT080	8028653123824	BIANCO WHITE	115,81		

## CONTENUTO - CONTENT :

2 elemento diritto da 1 mt.  
2 straight element 1 mt.  
1 elemento diritto da 0,5 mt.  
1 straight element 0,5 mt.  
1 curva 90°  
1 curve 90°  
1 raccordo TEE 90° MF-F con tappo condensa chiuso  
1 TEE joint 90° MF-F with closed condensation cap  
1 rosoni Ø 150 mm.  
1 little circle frame Ø 150 mm.  
2 fascetta murale  
2 adjustable wall clamp

**KIT COMPLETO MOD. 1**  
**FULL KIT MOD. 1**

**PZ. X CONF. - PCS FOR BOX: 1**



Ø	CODICE CODE	EAN 13	COLORE COLOR	EURO		
80	PPKIT080T1	8028653123831	NERO BLACK	119,31		
80	PBKIT080T1	8028653123855	BIANCO WHITE	119,31		

## CONTENUTO - CONTENT :

1 elemento diritto da 1 mt.  
1 straight element 1 mt.  
1 elemento diritto da 0,5 mt.  
1 straight element 0,5 mt.  
1 elemento telescopico 0,3 ÷ 0,6 mt.  
1 telescopic element 0,3 ÷ 0,6 mt.  
1 curva 90°  
1 curve 90°  
1 raccordo TEE 90° MF-F con tappo condensa chiuso  
1 TEE joint 90° MF-F with closed condensation cap  
1 rosoni Ø 150 mm.  
1 little circle frame Ø 150 mm.  
2 fascetta murale  
2 adjustable wall clamp

**KIT COMPLETO MOD. 2**  
**FULL KIT MOD. 2**

**PZ. X CONF. - PCS FOR BOX: 1**



Ø	CODICE CODE	EAN 13	COLORE COLOR	EURO		
80	PPKIT080T2	8028653123848	NERO BLACK	132,72		
80	PBKIT080T2	8028653123862	BIANCO WHITE	132,72		

## CONTENUTO - CONTENT :

1 elemento diritto da 1 mt.  
1 straight element 1 mt.  
2 elemento diritto da 0,5 mt.  
2 straight element 0,5 mt.  
1 elemento telescopico 0,3 ÷ 0,6 mt.  
1 telescopic element 0,3 ÷ 0,6 mt.  
1 curva 90°  
1 curve 90°  
1 raccordo TEE 90° MF-F con tappo condensa chiuso  
1 TEE joint 90° MF-F with closed condensation cap  
1 rosoni Ø 150 mm.  
1 little circle frame Ø 150 mm.  
2 fascetta murale  
2 adjustable wall clamp

# TUBI E ACCESSORI PER ASPIRAZIONE

## HOSES AND ACCESSORIES FOR SUCTION

Tubi in alluminio lega 3003 (99,9%) e relativi accessori, per aspirazione stufe e caldaie alimentate a gas e pellet.

*Aluminium alloy 3003 (99,9%) hoses and related accessories, for suction in boiler and stove powered by gas and pellet.*

### GRIGLIA DI ASPIRAZIONE IN ACCIAIO INOX STAINLESS STEEL SUCTION GRID

PZ. X CONF. - PCS FOR BOX: 1

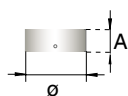

Ø	CODICE CODE	EAN 13	COLORE COLOR	EURO	DIMENSIONI IN MM. DIMENSIONS IN MM.		
					A		
50	PPGA51050X	8028653123916	INOX	6,00	35		
60	PPGA51060X	8028653123923	INOX	6,00	35		
80	PPGA51080X	8028653123879	INOX	10,35	35		
100	PPGA51100X	8028653123886	INOX	11,80	35		

### FLESSIBILE ALLUMINIO NATURALE ESTENSIBILE PER ASPIRAZIONE NATURAL FLEXIBLE ALUMINIUM EXTENSIBLE FOR SUCTION

PZ. X CONF. - PCS FOR BOX: 6



Ø	CODICE CODE	EAN 13	COLORE COLOR	EURO	DIMENSIONI IN MM. DIMENSIONS IN MM.		
					L MIN	L MAX	
60	FLXALN15060	8028653178466	NATURALE NATURAL	3,40	≈ 350	1500	
80	FLXALN080	8028653178176	NATURALE NATURAL	6,80	500	3000	
100	FLXALN100	8028653178183	NATURALE NATURAL	7,06	500	3000	

### FLESSIBILE ALLUMINIO BIANCO ESTENSIBILE PER ASPIRAZIONE WHITE FLEXIBLE ALUMINIUM EXTENSIBLE FOR SUCTION

PZ. X CONF. - PCS FOR BOX: 6



Ø	CODICE CODE	EAN 13	COLORE COLOR	EURO	DIMENSIONI IN MM. DIMENSIONS IN MM.		
					L MIN	L MAX	
50	FLXALC15050	8028653178473	BIANCO WHITE	4,20	≈ 350	1500	
60	FLXALC15060	8028653178480	BIANCO WHITE	4,20	≈ 350	1500	
80	FLXALC080	8028653178329	BIANCO WHITE	8,40	500	3000	
100	FLXALC100	8028653178336	BIANCO WHITE	9,71	500	3000	

### RIDUZIONE IN ALLUMINIO NATURALE D.50 - D. 40 NATURAL ALUMINIUM CUT LENGTH ADAPTOR D. 50 - D. 40

PZ. X CONF. - PCS FOR BOX: 1

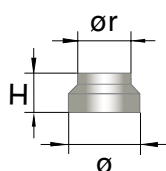

Ø	CODICE CODE	EAN 13	COLORE COLOR	EURO	DIMENSIONI IN MM. DIMENSIONS IN MM.		
					H	ør	
50	PPRC09050	8028653124180	NATURALE NATURAL	3,80	45	40	



Ø	CODICE CODE	EAN 13	COLORE COLOR	EURO		
/	PBKITASP	8028653123954	/	12,50		

**CONTENUTO - CONTENT :**

- 1 tubo in alluminio colorato bianco flessibile D. 50 mm., estensibile da 350 a 1500 mm.  
*1 flexible white painted aluminium hose D. 50 mm., extensible from 350 to 1500 mm.*
- 1 griglia di aspirazione in acciaio inox  
*1 stainless steel suction grid*
- 1 riduzione in alluminio naturale D. 50 - D. 40 mm.  
*1 natural aluminium cut length adaptor D. 50 - D. 40 mm.*

**CONDIZIONI DI VENDITA**  
**SALES CONDITIONS**

**ORDINI**

Tutti gli ordini s'intendono assunti a titolo di prenotazione e non impegnano la nostra società alla consegna anche parziale. Gli ordini, per essere evasi, dovranno avere un importo minimo di Euro 500 netto merce.

**PREZZI**

Salvo diverso accordo da approvarsi per iscritto, si applicano i prezzi in vigore al momento della consegna o spedizione. I prezzi, salvo diverso accordo, s'intendono per merce resa franco nostro magazzino.

**SPEDIZIONI**

La merce normalmente viaggia in Porto Assegnato, salvo accordi particolari in contrario. La merce viaggia a rischio e pericolo del committente anche se venduta franco destino.

**PAGAMENTI**

Le condizioni di pagamento sono quelle indicate in fattura e sono vincolanti. Trascorse le scadenze convenute, senza alcun avviso, saranno conteggiati gli interessi di mora calcolati secondo il tasso bancario medio praticato alla data della scadenza. I bolli tratta o ricevuta saranno a totale carico del Cliente.

**RISERVA DI PROPRIETA'**

Il trasferimento della proprietà della merce al Cliente avverrà, con ogni conseguente effetto, al momento dell'integrale pagamento del prezzo. Fino al momento in cui il venditore cede il diritto di proprietà, lo stesso si ritiene in diritto di recuperare tutto il materiale in disponibilità del compratore.

**RECLAMI**

Non si accettano reclami trascorsi 5 giorni lavorativi dalla data di ricevimento della merce, e devono essere recapitati per iscritto alla nostra sede.

**RESI**

Non si accetta merce di ritorno senza la nostra preventiva autorizzazione. L'autorizzazione deve essere rilasciata per iscritto e, in ogni caso, la resa è in Porto Franco nostro stabilimento.

**SOSPENSIONE DI ORDINI E FORZA MAGGIORE**

Qualora da parte dell'acquirente non venissero rispettate, anche solo parzialmente, le condizioni di vendita, la nostra società potrà sospendere le ulteriori consegne. La nostra società è esonerata dall'esecuzione degli obblighi derivanti dal contratto di vendita in qualunque caso di forza maggiore.

**MODIFICHE**

La nostra società si riserva di apportare, senza alcun preavviso, in qualsiasi momento e per qualsiasi ragione, qualunque modifica al presente catalogo ed agli articoli in esso contenuti che si rendesse tecnicamente necessaria.

**FORO COMPETENTE**

In caso di controversia ci riserviamo il diritto di scegliere il foro competente.

**ORDERS**

*All orders are intended at booking title and do not bind our company to delivery, even if partial. Orders will be accepted only if in an amount exceeding Euro 500 .*

**PRICES**

*Unless otherwise specified and only after written approval, valid prices are those in force at the time of delivery or despatch. Prices are meant for goods delivered EX WORKS.*

**SHIPMENTS**

*Goods are usually carried EX WORKS, unless otherwise agreed. Goods are carried at buyer's risk and danger even if sold free destination.*

**PAYMENTS**

*Payment conditions are those shown in the invoice and are binding. At the agreed expiries, without any notice, interest on delayed payment will be calculated according to the practiced average banking rate at the expiry date. Any draft or payment fee will be at full client's charge.*

**PROPERTY RETENTION**

*Ownership of the goods will be transferred to the Customer, with all obligations linked thereto, on completion of payment. Until the moment the seller has relinquished the ownership of the goods, the same is claimed to be entitled recovering all the material in the buyer availability.*

**CLAIMS**

*Claims are not accepted after 5 working days upon goods receipt. Claims must be issued in writing and sent to our headquarters.*

**RETURNED GOODS**

*Returned goods are not accepted without our previous authorization. The authorization must be released in writing and goods are returned free destination.*

**SUSPENSION OF ORDERS AND FORCE MAJEURE**

*If the buyer does not comply partially or in full with our sales conditions, our company can suspend further deliveries. Our company is exempt from the implementation of obligations deriving from the sales contract in whatever case of force majeure.*

**MODIFICATIONS**

*Our company retains the right to apply whatever modification at this catalog and all items inside deriving from technical reasons, without any previous notice, in any moment and for any reason.*

**COMPETENT JURISDICTION**

*In case of controversy we retain a right to decide on competent jurisdiction.*

MBM s.r.l.

Via Marmolada, 35 cap.20095 • Cusano Milanino (MI) • Tel 02.66 40 30 96 • Fax 02.66 40 30 88  
mbmitalia@mbmitalia.it • www.mbmitalia.it